

LUMEL

# PID TEMPERATURE CONTROLLER RE12S



USER MANUAL

CE

## CONTENTS

<b>1.</b>	<b>OVERVIEW</b> .....	<b>03</b>
	1.1. Features.....	03
	1.2. Ordering information.....	04
<b>2.</b>	<b>SPECIFICATIONS</b> .....	<b>05</b>
<b>3.</b>	<b>INSTALLATION</b> .....	<b>09</b>
	3.1. Safety Information.....	09
	3.2. Terminal connections.....	11
	3.3. Sensor input wiring.....	12
	3.4. Control output wiring.....	12
<b>4.</b>	<b>PROGRAMMING</b> .....	<b>15</b>
	4.1. Function menu.....	15
	4.2. Keys description.....	17
	4.3. Indications and display.....	17
	4.4. Level 0-Input parameters.....	18
	4.5. Level 1-Output parameters.....	20
	4.6. Level 2-Auxiliary output modes.....	23
	4.7. Level 3-Alarm 2 module.....	26
	4.8. Level 4-Special functions.....	27
	4.9. Level 5-Communication parameters.....	30
	4.10. Level 6-Lockout module.....	31
	4.11. Level 9-Profile Parameter.....	33
<b>5.</b>	<b>USER GUIDE</b> .....	<b>38</b>

# 1. OVERVIEW

## 1.1. FEATURES



48 x 48



### Salient features

- **Profile Control**

Profile control is also includes. 8 programs each of 16 Steps

- **Universal I/O**

Inclusion of all Possible Inputs and outputs in a single Product

- **Adaptive Tunning**

For better performance, a new feature of adaptive tuning is added along with existing Self & Auto tuning.

- **Selectable lower display**

User selectable lower display options enable quick setting of different parameters such as

Set points, Alarms, PID values, Tuning etc.

- **Zone PID**

4 programmable control zones.

- **Outputs**

Output is selectable as control output or retransmission output.

- **Special Modes**

User selectable special modes

Heat-Cool PID, Auto/Manual, Single point ramp/soak, Soft start.

### Others

- Dual 4 digit display
- Digital filtering
- Sensor break indication
- Sensor error compensation
- Programmable parameter lockouts
- 90 to 270 VAC/DC
- IP65 front panel protection
- RS-485 MODBUS communication

## 1.2. ORDERING CODE

Product code	Input	Supply voltage	Communication RS-485
RE12S	Universal	90-270 VAC / DC	YES

## 2. SPECIFICATIONS

### TECHNICAL SPECIFICATIONS

#### • DISPLAY

48 X 48 – Dual 4 digit 7- segment LED. **Upper Display** : 15.3mm high White (process value). **Lower Display** : 8.0mm high Green (selectable).

<b>LED Status Annunciators</b>	Main output (1), Alarm output (2,3), Manual output(M) Tune (T), Adaptive Tune (A)
--------------------------------	-----------------------------------------------------------------------------------

#### • INPUT

<b>Input</b>	<b>Thermocouple:</b> J,K,T,R,S,C,E,B,N,L,U,W,Platinel II. <b>RTD:</b> PT100. <b>Signal inputs:</b> -5 to 56 mV, 0 to 10 VDC, 0 to 20 mA DC (Programmable scale type)
<b>Sampling Time</b>	200 ms.
<b>Resolution</b>	1/0.1° for TC/RTD. 1/0.1/0.01/0.001 for Analog input. (Decimal point position)
<b>Indication accuracy</b>	± 0.25% of span or 1° whichever is greater. (20min of warmup time ). Cold Junction Calibration accuracy in TC mode ±5° C. For RTD inputs : 0.1% of F.S. ± 1°C
<b>Digital filtering</b>	OFF, 1 to 99 sec.

#### • CONTROL OUTPUT

<b>Relay contact output</b>	<b>Relay 1 , Relay 2 :</b> 7A@250VAC or 30VDC Life expectancy : 100000 cycles at maximum load rating <b>Relay 3 :</b> 10A@277VAC or 28VDC Life expectancy : 100000 cycles at maximum load rating
<b>SSR drive voltage output</b>	15 VDC
<b>Current output</b>	Range: 0 -20 mA DC, 4-20 mA DC (Factory set) Action: Control. Update rate: PID Update - Every Cycle time. Analog Output - 100 msec. Maximum output load resistance: 500E.

• **ALARM OUTPUT**

<b>Relay contact output</b>	Relay 1, Relay 2 : 7A@250VAC or 30VDC Life expectancy : 100000 cycles at maximum load rating Relay 3 : 10A@277VAC or 28VDC Life expectancy : 100000 cycles at maximum load rating
-----------------------------	--------------------------------------------------------------------------------------------------------------------------------------------------------------------------------------------

• **RETRANSMISSION OUTPUT**

<b>Current output</b>	Range: 0 / 4-20mA, Action: Retransmission Update rate: 100 ms, Maximum output load resistance: 500 Ω
-----------------------	---------------------------------------------------------------------------------------------------------

• **FUNCTION**

<b>Main control</b>	Control: PID or ON/OFF. Output: Time proportioning or Linear DC. Proportional band: 0 to 400°C Integral time: 0 to 3600 sec Derivative time: 0 to 200 sec Cycle time: 0.1 to 100.0sec. Auto tune. Programmable % output.
<b>Zone PID</b>	4 programmable control zones.
<b>Heat-cool PID mode</b>	Control: PID or ON/OFF Output: Time proportioning. Proportional gain: 0 to 400 Cycle time: 0.1 to 100.0sec. Heat/Cool dead band overlap: Programmable
<b>Alarms</b>	Modes: Deviation high, Deviation low, Band, Full scale high, Full scale low, Sensor break. Operation: Absolute or Deviation mode Hysteresis: Programmable Hold/Standby mode: Programmable Annunciator: Programmable Reset action: Programmable - Automatic or latched Probe break action: Upscale
<b>Profile</b>	Number of profile programs : 8 Number of steps in each program : 16 Other profile parameters : Link profiles, Programmable repeat cycles, Power down resume/restart options, Deviation hold, Alarm at each step with settable alarm duration.

### • SERIAL COMMUNICATION

<b>Interface standard</b>	RS485
<b>Communication address</b>	1 .... 99, maximum of 32 units per line.
<b>Transmission mode</b>	Half duplex.
<b>Transmission protocol</b>	MODBUS RTU.
<b>Transmission distance</b>	500 m maximum.
<b>Transmission speed</b>	115200, 57600, 38400, 9600, 4800, 2400 bits/sec.
<b>Parity</b>	None, Odd, Even.
<b>Stop bits</b>	1 or 2.
<b>Response time</b>	100ms (max and independent of baud rate).

### • ENVIRONMENTAL CONDITIONS

<b>Operating range</b>	0 .... 50°C.
<b>Storage range</b>	-20 .... 75°C.
<b>Storage humidity</b>	85% max. RH (non condensing) from 0 to 50°C.
<b>Altitude</b>	2000m
<b>Over voltage category</b>	2
<b>Pollution degree</b>	2
<b>Usage location</b>	Indoor/dry

### • POWER SUPPLY

<b>Power supply</b>	90...270 VAC/DC
<b>Frequency</b>	50/60Hz.
<b>Power consumption</b>	6VA max.

### • ISOLATION BREAKDOWN RATINGS

<b>AC line w.r.t. all inputs and outputs</b>	1500 volts
<b>All other inputs and outputs w.r.t. Relay contacts</b>	3000 volts

### • SAFETY AND EMC STANDARDS

<b>Compliance</b>	CE.
<b>LVD</b>	As per IEC 61010-1:2010+AMD1:2016
<b>EMC</b>	As per IEC 61326-1:2020
<b>Panel sealing</b>	IP65.

- **WEIGHT: 101 grams**
- **HOUSING:** Flame retardant engineering plastic
- **INPUT SENSOR RANGES (for 1°C resolution):**

Sensor type	Range	Sensor type	Range
J	- 200 to 750°C	E	- 200 to 750°C
K	- 200 to 1350°C	B	+ 400 to 1820°C
T	- 200 to 400°C	N	- 200 to 1300°C
R	0 to 1750°C	L	- 200 to 600°C
S	0 to 1750°C	U	- 200 to 900°C
C	0 to 2300°C	W	0 to 2300°C
Platinel II	0 to 1390°C	PT100	- 100 to 850°C

• **SIGNAL INPUTS**

Input type	Range
Linear mV	-5 to 56mV
Voltage	0 to 10 VDC
Current	0 to 20mA

• **INPUT DIP SWITCH SELECTION**

**NOTE :** The following parameters have been modified.

Short respective pins of JP1 as per the table given below for hardware selection of input sensor types :

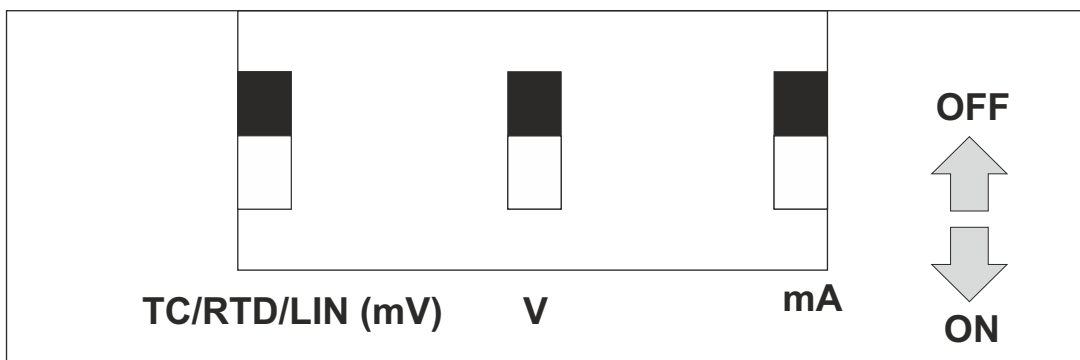

Push the respective switches downwards for hardware selection of Input sensor types.

Note : Sensor selection to be done in level 0 of programming also.

## 3. INSTALLATION

### 3.1. SAFETY INFORMATION

#### • SAFETY SUMMARY

This manual is meant for the personnel involved in wiring installation, operation, and routine maintenance of the equipment. All safety related modifications; symbols and instructions that appear in this operating manual or on the equipment must be strictly followed to ensure the safety of the operating personnel as well as the instrument.

If the equipment is not handled in a manner specified by the manufacture it might impair the protection provided by the equipment.

 **CAUTION:** Read complete instructions prior to installation and operation of the unit.

 **CAUTION:** Risk of electric shock.

#### • INSTALLATION INSTRUCTIONS

 **CAUTION:**

1. This equipment, being built-in-type, normally becomes a part of the main control panel and in such case the terminals do not remain accessible to the end user after installation and internal wiring.
2. Conductors must not come in contact with the internal circuitry of the equipment or else it may lead to a safety hazard that may in turn endanger life or cause electrical shock to the operator.
3. Circuit breaker or mains switch must be installed between power source and supply terminals to facilitate power 'ON' or 'OFF' function. However this switch or breaker must be installed in a convenient position normally accessible to an operator.

 **CAUTION:**

1. The equipment shall not be installed in environmental conditions other than those specified in this manual.
2. Fuse Protection - The equipment does not contain built-in fuse. Installation of external fuse for electrical circuitry is highly recommended. Recommended rating of such fuse shall be 275VAC/1Amp.
3. Since this is a built-in type equipment (finds place in main control panel), its output terminals get connected to host equipment. Such equipment shall also comply with basic EMI/EMC and safety requirements like IEC 61326-1 and IEC 61010 respectively.
4. Thermal dissipation of equipment is met through ventilation holes provided on chassis of equipment. Such ventilation holes shall not be obstructed else it can lead to a safety hazard.
5. The output terminals shall be strictly loaded to the manufacturer specified values/range.

#### • MAINTENANCE

1. The equipment should be cleaned regularly to avoid blockage of ventilling parts.
2. Use soft cloth for cleaning. Do not use isopropyl alcohol or any other oraganic cleaning agent.



## • WIRING INSTRUCTIONS

### CAUTION:

- 1.To prevent the risk of electric shock power supply to the equipment must be kept OFF while doing the wiring arrangement.
- 2.Terminals and electrically charged parts must not be touched when the power is ON.
- 3.Wiring shall be done strictly according to the terminal layout with shortest connections. Confirm that all connections are correct.
- 4.Use lugged terminals to meet M3.5 screws.
- 5.To eliminate electromagnetic interference use of short wire with adequate ratings and twists of the same in equal size shall be made.
- 6.Cable used for connection to power source, must have a cross section of 1 or greater. These wires shall have insulation capacity made of at least 1.5KV.

## • ELECTRICAL PRECAUTIONS DURING USE

Electrical noise generated by switching of inductive loads can create momentary disruption, erratic display, latch up, data loss or permanent damage to the instrument. To reduce noise:

- A) Use of MOV across supply of temperature controller & snubber circuits across loads are recommended.
- B) Use separate shielded wires for inputs.
- C) The unit should preferably be shielded from the contactor.

## • INSTALLATION GUIDELINES

**Mechanical Installation:** For installing the controller

- 1.Prepare the panel cutout with proper dimensions as shown.

### • OVERALL DIMENSIONS (All dimensions in mm)

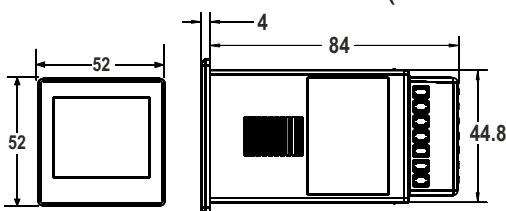

Panel Cutout : 46mm x 46mm

- 2.Remove the clamp from the controller.

- 3.Push the controller into the panel cutout. Secure the controller in its place by pushing the clamp from the rear side.

### CAUTION

The equipment in its installed state must not come in close proximity to any heating sources, caustic vapors, oils, steam, or other unwanted process by-products.

**EMC Guidelines:**

1. Use proper input power cables with shortest connections and twisted type.
2. Layout of connecting cables shall be away from any internal EMI source.

**3.2. TERMINAL CONNECTIONS**

RE12S  
 Supply:90 to 270VAC/DC  
 6VA max, 50/60Hz  
 RLY1,2:7A@250V AC/30VDC  
 RLY3:10A@277V AC/28VDC

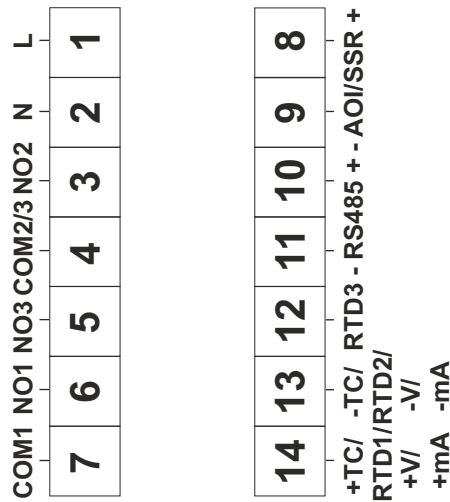

**Note:** "PIN TYPE LUG" is suggested for pannel wiring

### 3.3. SENSOR INPUT WIRING

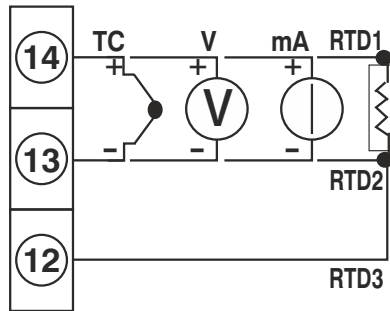

TC - Thermocouple (J, K, T, R, S, C, E, B, N, L, U, W, Platine II).

V - Voltage Input (0 to 10 VDC).

mA - Current Input (0 to 20mA DC)

RTD - PT100.

**NOTE :1) Refer input type selection in level 0 of programming menu.**

**2) Refer Input DIP switch selection as in point 13. on page -6.**

**3) For 2 Wire RTD short terminals 13 & 12.**

### 3.4. CONTROL OUTPUT WIRING

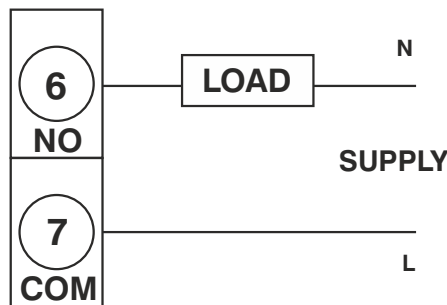
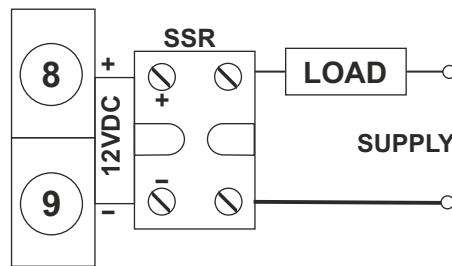

*Fig 1. Main/Control Output – Relay drive to load (resistive load less than 1A)*

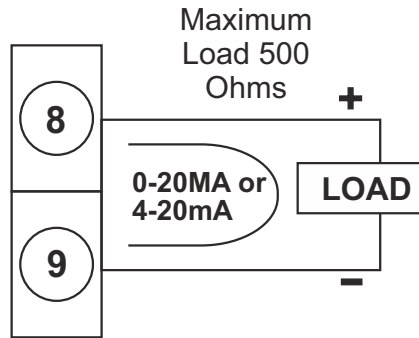

**Fig2. Main/Control Output– Relay/SSR to drive contactor (For single phase)**

**NOTE:** Use snubber as shown above to increase life of internal relay of temperature controller.



**Fig3. Main/Control Output– Pulsed voltage to drive SSR**



**Fig4. Main / Control Output – Linear Current.**

**• Possible Output Configurations:**

Variant	Output	Analog Control	Retransmission	RLY 1	RLY 2	RLY 3
RE12S	Relay	P	NP	Control Output	AL1	AL2
	Aout	NP	P	NP	Control Output	AL2
	SSR	NP (AOI as SSR)	NP	NP	AL1	AL2

**\*Note :** Possible = P ; Not-Possible=NP ; Alarm=AL  
 When main output in Level 4 is selected as Analog Output.  
 Alarm 1 Relay (i.e Relay 2) act as control output.

# 4. PROGRAMMING

## 4.1. Function menu

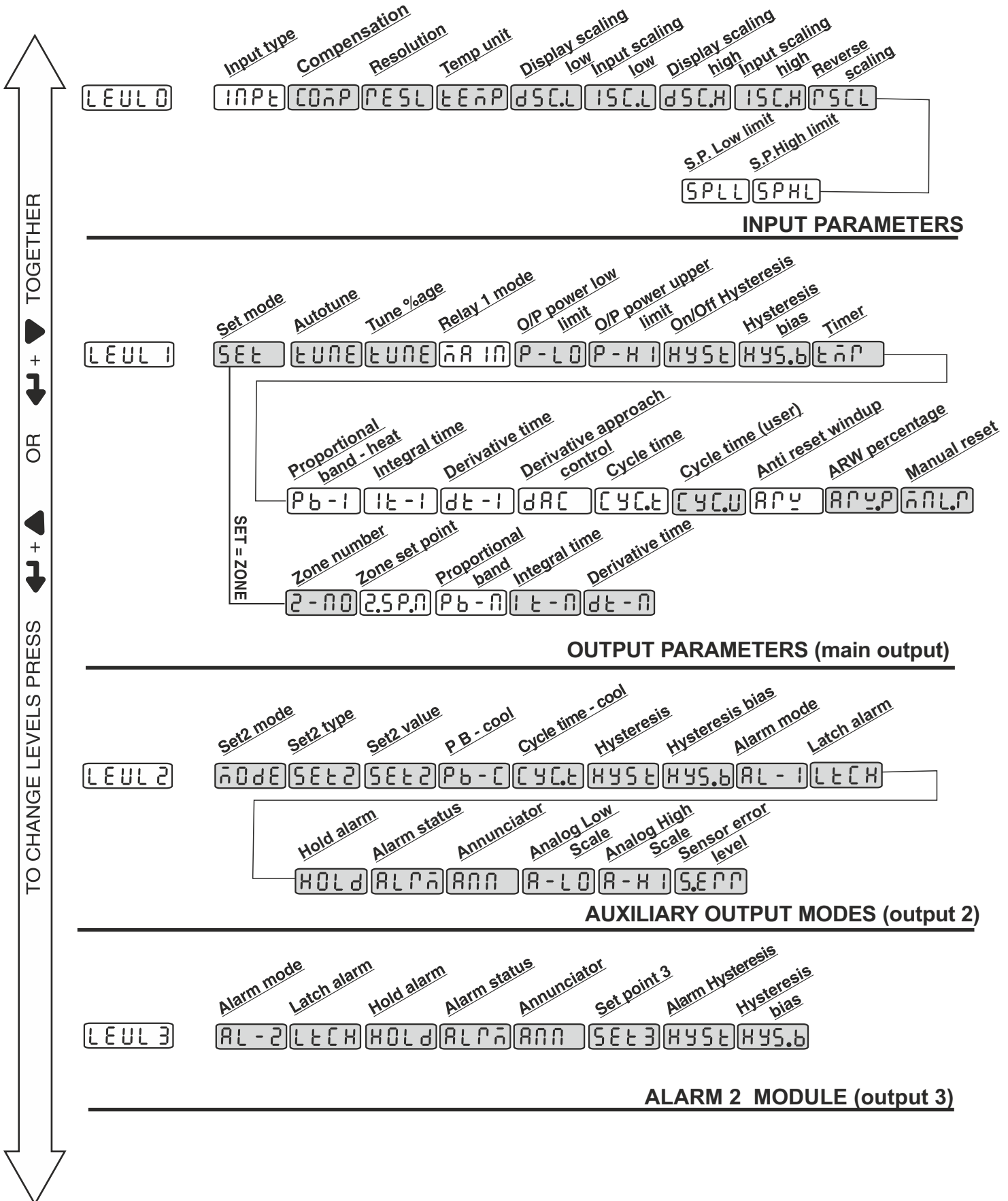

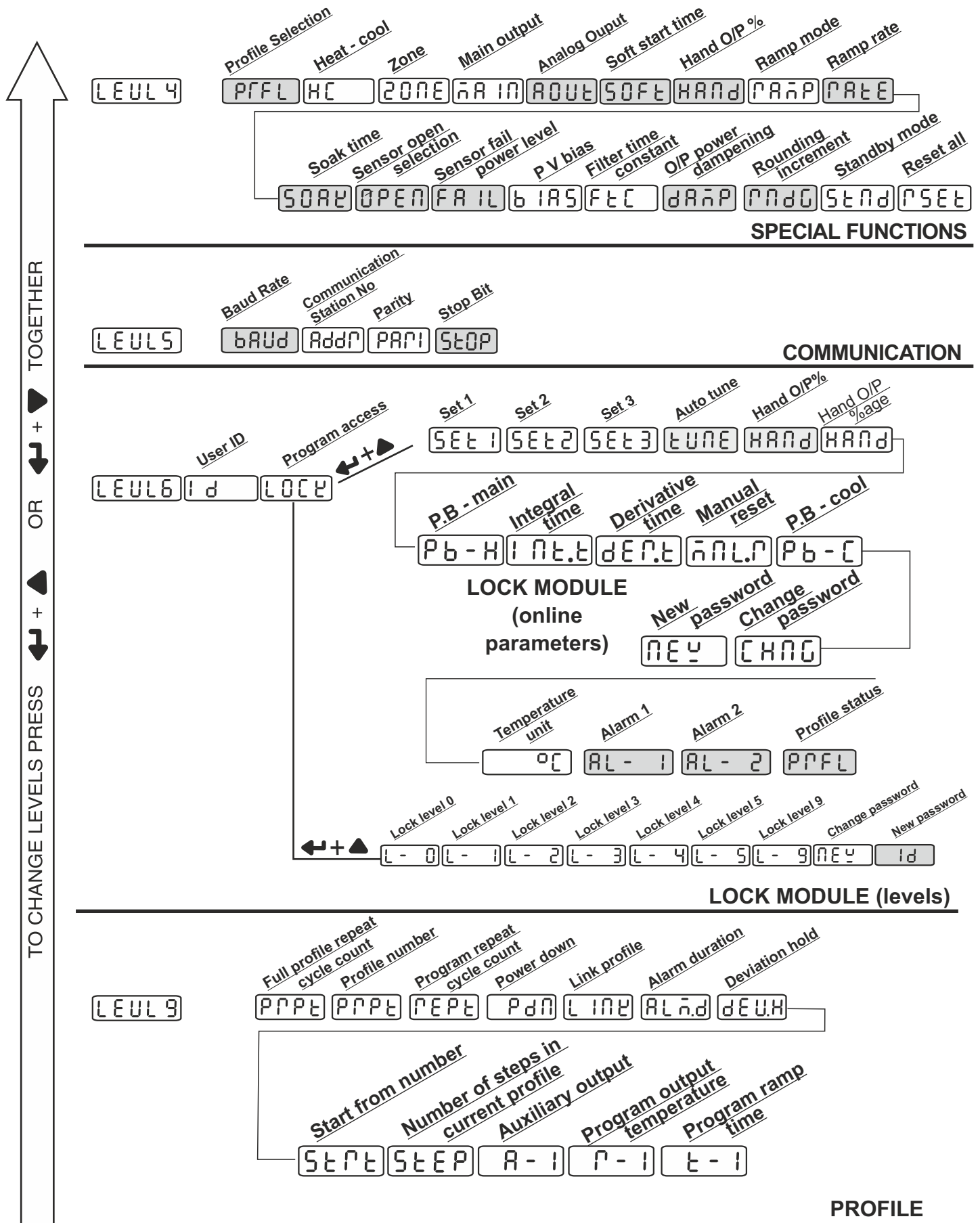

☞ Appearance of all shaded menus dependent on selection of other parameters. Refer programming for further details.

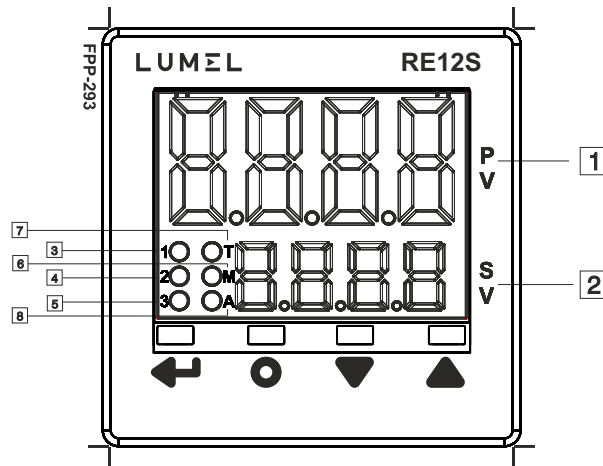

## 4.2. KEYS DESCRIPTION

Functions	Key press
To enter or exit program mode	▲ + ▼ together for 3 seconds
To change levels	▲ or ▼ when 'LEVL' is displayed. ← + ▲ / ▼ to increase or decrease the level number.
To view function on the same level and to display the current option.	▲ or ▼ key once to view the next / previous function.
To increase or decrease the value of a particular function.	← + ▲ to increase and ← + ▼ to decrease the function value.
To view and change parameters online	○ key to view the parameter and ○ + ▲ ▼ to scroll through the parameters. Press ← + ▲ / ▼ to change parameter value.

**NOTE:** The unit will autoexit program mode after 30 seconds of inactivity.

## 4.3. INDICATIONS AND DISPLAY

1 Process-value (PV)	Display the process temperature value.
2 Set-value (SV)	Displays the value of the lower display option selected. By default display is set1 value.
3 Relay 1 (1)	Indicates the status of Main output (relay 1).
4 Relay 2 (2)	Indicates the status of Alarm output (relay 2).
5 Relay 3 (3)	Indicates the status of Alarm output (relay 3).
6 M	Indication for Fixed Manual output.
7 T	Indication for Tuning in progress.
8 A	Indication for Adaptive tuning in progress



## 4.4. LEVEL 0 - INPUT PARAMETERS

### • PROGRAMMING OF LEVELS

Display	Name & Description	Range	Display condition	Default value
INPE	<u>Input type</u> Select input type as Thermocouples: J,K,T,R,S,C,E, B,N,L,U,W. Platinel II. RTD: PT100 Signal Inputs: Linear mV (-5 to 56mV), Voltage (0 to 10V), Current (4 to 20mA). Refer table on page 6 for input ranges.	J / K / E / R / S / C / E / B / N / L / U / V / P t 100 P100 / 5V 10V / 20mA	—	J
COMP	<u>Compensating</u>	NO / YES	TC inputs.	YES
RESL	<u>Resolution</u>	TC * / RTD: 1 / 0.1 Analog input: 1 / 0.1 / 0.01 / 0.001	Not prompted for R, S, and B type thermocouple.	1
TEMP	<u>Temperature unit</u>	°C / °F	TC/RTD inputs.	°C
DSCL	<u>Display value scaling point1</u> <sup>#1</sup> Feed the value of the display required at the lower value of analog input	+9999 to Display value scaling point2	Analog input.	0
ISCL	<u>Input value scaling point1</u> Feed the lower value of the analog input signal.	0.0mA / - 5.0 mV / 0.0V to Input value scaling point 2	Analog input.	As per input type selected.
DSCH	<u>Display value scaling point2</u> <sup>#1</sup> Feed the value of display required at the higher value of analog input	Display value scaling point 1 to 9999	Analog input.	9999

\* Fixed 1°C resolution for R, S, B type thermocouple.

Display	Name & Description	Range	Display condition	Default value
ISC.H	<u>Input value scaling point2</u> Feed the higher value of the analog input signal.	Input value scaling point1 to 20.00 mA / 55mV / 10.00V	Analog input.	As per input type selected.
PSCL	<u>Reverse scaling</u> Display scaling points can be reversed.	NO/YES	Analog input.	NO
SPHL	<u>Set point high limit</u> #1	Set point low limit to max. sensor range value. Set point low limit to 9999 for analog input.	—	750
SPLL	<u>Set point low limit</u> #1	Min. range of sensor to Set point high limit. -1999 to Set point high limit for analog input.	—	-200

- Note:** 1. Whenever resolution is changed from 1 to 0.1 SPLL and SPHL is limited to -199 and 999 respectively.  
2. #1 - Display is with fixed 1° resolution for TC/RTD and as per decimal point selected for analog input.

## Thermocouple Compensation :

### COMP = YES

Configure Yes if compensating cable is connected as thermocouple extension. Yes should also be configured in the case if the sensor is directly connected to the terminal without extension.

### COMP = NO

Configure No if non-compensating cable is connected as the thermocouple extension.

**PARAMETER EXPLANATIONS :**

• **TEMPERATURE UNIT:**

The temperature unit is selectable between °C and °F. When temperature unit is changed, the temperature ranges will also be changed according to the present selection of unit. If changed, be sure to check all parameters.

• **RESOLUTION:**

The resolution is selectable between 1 and 0.1 for TC and RTD inputs whereas it is selectable between 1, 0.1, 0.01,0.001 for analog inputs. If changed, be sure to check all parameters.

• **SCALING FOR ANALOG INPUT:**

To scale the controller, two scaling points are necessary. Each scaling point has a coordinate pair of Display Values and Input Values. It is recommended that the two scaling points be at the low and high ends of the input signal being measured. Process value scaling will be linear between and continue past the entered points to the limits of the input range. (Factory settings example will display 0.0 at 0 mA input and display 9999 at 20.00 mA input.)

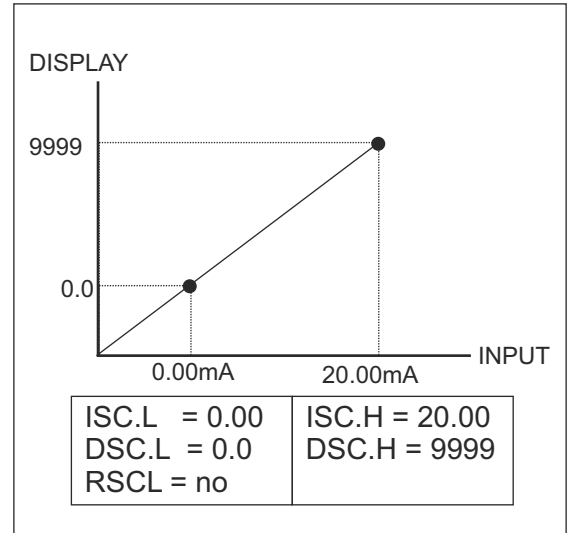

Reverse acting indication can be accomplished by setting **reverse scaling** parameter as YES. In this case **referring the above eg.** for 0.00 mA input the display will show 9999 and 20.00 mA input the display will show 0.0

**NOTE :** This change will not be visible in the programming menu.

• **SET POINT LIMIT VALUES:**

The controller has programmable high and low set point limit values to restrict the setting range of the set point. Set the limit values so that the temperature set point value cannot be set outside the safe operating area of the process.

**4.5. LEVEL 1 - OUTPUT PARAMETERS**

Display	Name & Description	Range	Display condition	Default value
SEt	Set Mode	ALL / ZONE	Zone PID = YES in level 4.	ALL
tUNE	Auto tune	OFF / SEt / REt / Adt	PID control	OFF

Display	Name & Description	Range	Display condition	Default value
εUNε	<u>Tune percentage</u>	P.AU, 75 to 100	Tune = ON	P.AU
̄R 1n	<u>Main Output Mode</u>	PE / Fd	Heat-cool=NO.	PE
P-L0	<u>Output power lower limit</u>	0% to o/p power high limit; -100% to o/p power upper limit (in heatcool mode)	PID control	0 (-100 for heat - cool mode)
P-H1	<u>Output power upper limit</u>	O/p power low limit to 100 %	PID control	100
HYSε	<u>ON-OFF control hysteresis</u>	0.1 to 99.9	ON-OFF control*	1.0
HYS.b	<u>Hysteresis bias</u>	TC/RTD: -9.9 to 9.9° Analog input: -9.9 to 9.9 as per decimal point selected.	ON-OFF control*	0.0
εn̄n	<u>Timer</u>	0.0 to 99.9 minutes	Main= Fd and control is ON-OFF.*	0.0
Pb-1	<u>Proportional band- heat</u>	0 to 4000	Not For ON-OFF	10
Iε-1	<u>Integral time</u>	0 to 3600 sec.	Not For ON-OFF	120
dε-1	<u>Derivative time</u>	0 to 200 sec.	Not For ON-OFF	30
dAC	<u>Derivative approach control</u>	0.5 to 5.0 (x band)	PID control	1.0
CYCε	<u>Cycle time</u>	USER/ USPF/A 15.0	PID control	USER
CYC.U	<u>Cycle time-user</u>	0.1 to 1000 sec	Cycle time = USER	15.0

Display	Name & Description	Range	Display condition	Default value
	<u>Anti-reset windup</u>	AUTO/ANAL	PID control	AUTO
	<u>Anti-reset windup %</u>	5.0 to 100 %	—	25.0
	<u>Manual Reset</u>	- 99.9 to 99.9 (for 0.1° resolution) 99 to 99 °C (for 1°) - 999 to 999 (for analog input)	Proportional band > 0 and Integral time = 0.	0

If Set Mode = All and Zone PID = YES, The parameters except the shaded ones (i.e. Pb-1, It-1, dt-1) will be prompted.

If Set Mode = Zone and Zone PID = YES, the following parameters will be prompted.

Display	Name & Description	Range	Display condition	Default value
	<u>Zone number</u>	1 to 4	Zone PID= YES(in level4)	1
	<u>Zone set point</u>	SPLL to SPHL	—	0
	<u>Proportional band</u>	0 to 400.0°	—	10
	<u>Integral time</u>	0 to 3600 sec.	Pb - n > 0	120
	<u>Derivative time</u>	0 to 200 sec.	Pb - n > 0	30

\*NOTE: For Proportional band, Integral time and Derivative time n = 1 to 4

**PARAMETER EXPLANATIONS :**

**• AUTO TUNING:**

Auto tuning is a function whereby the controller learns the process characteristics by itself and automatically sets the required P,I and D values. The new P,I,D parameters will be stored in non-volatile memory automatically. TUNE ON is indicated by 'T' LED blinking. (For detailed explanations of PID parameters refer USER GUIDE).

- **OUTPUT POWER LIMITS:**

These parameters are used to limit the minimum and maximum controller output power. The output power lower limit will ensure that a minimum percentage of output (as per requirement) is available in case any process disturbances or setpoint changes occur. The output power high limit ensures that in case any process disturbance or set point changes occur, the maximum value of output is limited to a value as per requirement.

- **TIMER:**

TIMER is main output restart time. In this main output once turned OFF will turn ON only after set time even if the temperature has increased and is more than the set temperature. This is needed to prevent the compressor from restarting in a short time (less than the set time).

- **CYCLE TIME:**

There are 3 selectable modes for programming cycle time:

USER: User can program the cycle time. The mode will be altered to Auto when put to autotune.

Usr.F: User can fix the cycle time. This has the highest priority.

Auto: This is recommended. The cycle time value is calculated automatically during autotune.

- **ANTI RESET WINDUP:**

The anti-reset windup (ARW) inhibits the integral action until the PV is within the proportional band thus reducing overshoot on start-up. If the selection is -

1. Auto: The value will be calculated automatically during autotune (Recommended).

2. ManL: The value can be fed manually by the user.

## 4.6. LEVEL 2 - AUXILIARY OUTPUT MODES

Display	Name & Description	Range	Display condition	Default value
	<u>Set 2 Mode</u> *	ALPn / NONE /Fd / rEV	Not for Heat-cool mode.	ALPn
	<u>Set 2 Type</u>	AbS / dEV	Set2 mode = Fd / rEV.	dEV
	<u>Set 2 Type</u>	SPLL to SPHL	Not prompted if Set2 mode = alarm & alarm mode = S. Brk.	0
	<u>Proportional band-Cool</u>	0.0 to 400.0	Heat-cool mode	0.0
	<u>Cycle time-Cool</u>	0.1 to 100.0 Sec.	Pb-C>0	15.0
	<u>Hysteresis</u>	0.1 to 99.9°C	1. Set2 mode = Fd / rEV/ALrM (not sensor break); 2. Heat cool mode (Pb-C=0)	1.0

NOTE: \* - If set2 mode = none, no other parameters will be prompted.

Display	Name & Description	Range	Display condition	Default value
<b>HYS.b</b>	<u>Hysteresis bias</u>	TC/RTD: - 9.9 to 9.9 °C Analog input: - 9.9 to 99 as per decimal point selected.	1. Set2 mode=Fd/rEV /ALrM (not sensor break); 2. Heat-cool mode (Pb-C=0)	0.0
<b>AL -1</b>	<u>Alarm1 mode</u>	OFF / dUHI /dULO/bANd /FSHI /FSLO /SbPE	Set2 mode=ALrM	dUHI
<b>LECH</b>	<u>Alarm latch</u>	OFF / ON	These parameters are not prompted if Alarm1 mode is OFF.	OFF
<b>HOLD</b>	<u>Hold Alarm</u>	OFF / ON		OFF
<b>ALPn</b>	<u>Relay status for Alarm1</u>	EN / dEN		EN
<b>ANN</b>	<u>Alarm Annunciator</u>	OFF / ON		OFF
<b>A-LO</b>	<u>Analog low scaling</u>	-9999 to 9999	For Analog retransmission if Main output = Aout in Level 4	0
<b>A-HI</b>	<u>Analog high scaling</u>	-9999 to 9999	For Analog output if Main output = Aout	1000
<b>S.EPn</b>	<u>Sensor error level</u> Incase of sensor failure the output can be set to high or low value of range.	HIGH / LOW	For Analog output if Main output = Aout	HIGH

**NOTE:**

In **HC mode** only the following parameter will be prompted :-

1. Set 2 value - this parameter will be prompted as db (dead band)
2. Proportional band - cool (Pb-C)
3. Cycle time - cool (cyc.t)

In case of analog retransmission only the following parameters will be prompted:

1. A-LO : Analog low scaling.
2. A-HI : Analog high scaling.
3. S.ERR : Sensor error level.

Display is with fixed 1<sup>o</sup> resolution for TC/RTD and as per decimal point selected for analog input.

**PARAMETER EXPLANATIONS :**

- **SET 2 MODE:**

AlrM: Set2 can be programmed as alarm.

NonE: If set2 is not required it can be programmed as none.

Fd: Set2 programmed in cooling mode.(output ON when above the setpoint).

rE: Set2 programmed in heating mode.(output ON when below the setpoint)

- **SET 2 TYPE:**



AbS: Absolute alarm is a self-existent alarm independent of the main set point.

DEV: The alarm is activated at an error on the main set point.

- **ALARM MODES:**

(Refer **USER GUIDE** for detailed explanation).

- **ALARM LATCH:**

When Latch is ON, the alarm once activated remains activated even when the error is removed. To deactivate the alarm, it has to be acknowledged by selecting AL-NO from the front online options and pressing  + 

- **HOLD ALARM:**

When HOLD is ON, in any alarm mode, it prevents an alarm signal on power-up. The alarm is enabled only if the process temperature is within the alarm range.

- **ALARM ANNUNCIATOR:**

When alarm annunciator is ON, during alarm condition, visual annunciation is given by the upper display altering between AL-NO and process temperature where NO is the alarm number. The annunciator may be disabled by selecting function ANN as OFF.

- **SENSOR ERROR LEVEL :**

This parameter determines the analog retransmission output level in case of sensor failure. For eg : In case of 4-20mA retransmission output, if the sensor error level is set to High, 20mA will be available at the output at all times incase of input sensor failure.



## 4.7. LEVEL 3 - ALARM 2 MODULE





Display	Name & Description	Range	Display condition	Default value
AL-2	Alarm 2 mode	OFF/dUHI /dULO/bANd /FSHI/FSLO /S.brk.	-	dUHI
LtCH	Alarm latch	OFF/ON	These parameters are not prompted if Alarm 2 mode is OFF.	OFF
HOLD	Hold Alarm	OFF/ON		OFF
ALPn	Relay status for Alarm1	EN/dEN		EN
ANN	Alarm Annunciator	OFF/ON		OFF
SEt3	Set 3 Value	SPLL to SPHL	These parameters are not prompted if Alarm 2 mode is OFF./brk	0
HYS	Alarm Hysteresis	0.1 to 99.9°C for TC / RTD; 99°C for Analog Input		1.0
HYS.b	Hysteresis bias	- 9.9 to 9.9 °C (for TC/ RTD); - 99 to 99 for AIN models decimal point as per selected		0.0

## PARAMETER EXPLANATIONS:

For parameter explanations refer Level 2.

## 4.8. LEVEL 4 - SPECIAL FUNCTIONS

Display	Name & Description	Range	Display condition	Default value
PPFL	<u>Profile</u>	ON / OFF	—	OFF
HC	<u>Heat cool mode</u>	NO / YES	—	NO
ZONE	<u>Zone</u>	NO / YES	—	NO
MAN	<u>Main Output</u>	PLY / AUTO / SSR	—	PLY
AOUT	<u>Analog output</u>	4-20; 0-20	PLY / AOUT	4-20
SOFT	<u>Soft start time</u>	OFF, 1 to 999 minutes.	PID control	OFF
HAND	<u>Hand output percentage</u>	OFF, O/P power low limit to O/P power high limit.	PID control	OFF
RAMP	<u>Ramp mode</u>	OFF / HOLD / ON	—	OFF
RATE	<u>Ramp rate</u>	1 to 9999 degree/hour.	Ramp mode = ON/HOLD.	100
SOAK	<u>Soak time</u>	0 to 1440 minutes	Ramp mode = ON/HOLD.	0
OPEN	<u>Sensor open condition</u>	AUTO / MANL	PID control	AUTO
FAIL	<u>Sensor fail power level</u>	0 to 100%; -100 to 100 % in case of heat-cool mode.	Sensor open condition = MANL.	0
BIAS	<u>PV bias (Display Offset)</u>	- 999 to +999 for TC (RTD) & - 999 to +99.9 for AIN models decimal point as per selected.	—	0.0

Display	Name & Description	Range	Display condition	Default value
	<u>Filter time constant</u>	OFF, 1 to 99 seconds	—	1
	<u>Output power dampening</u>	OFF, 1 to 99 seconds	Analog output model.	1
	<u>Rounding increment</u>	0.1 to 10.0 for TC/RTD Display as per decimal point selected for analog input.	TC / RTD with resolution = 1°C or Analog input.	1.0
	<u>Standby mode</u>	NO / YES	—	NO
	<u>Reset</u>	NO / YES	—	NO

**PARAMETER EXPLANATIONS :**

• **MAIN OUTPUT:**

The main control output is selectable between Relay, Aout & SSR. If main output is selected as Aout, all the control parameters will be applicable to the output connected to Relay 2 but the set point applicable will be Set 1 (main set point). For analog retransmission, the main output must be set to Aout for PID control with Aout, keep it at Relay

• **SOFT START TIME:**

Soft start time can be programmed in situations where full output is not required at power ON. The time duration for the output to rise from 0% to 100% is programmed as soft start time.

• **HAND OUTPUT PERCENTAGE:**

This parameter can be used when a fixed percentage of output is desired. For example: If 4-20mA analog output is being used and the desired output is 12mA, the hand percentage can be programmed as 50%. This will ensure that the analog output available is fixed 12 mA i.e. 50%. In case of relay output models, the relay ON time and OFF time will be according to the programmed Hand output percentage i.e. For 50% hand o/p percentage and cycle time 15sec, relay will be ON for 7.5sec and OFF for 7.5 sec.

• **RAMP - SOAK:**

The set point ramp feature can reduce thermal shock to the process, reduce temperature overshoot on start-up or set point changes, or ramp the process at a controlled rate. The soak feature can be used to hold the process at a preset temperature for a preset time.

Ramp modes:

Ramp OFF: Controller will be simple PID / ON-OFF controller with P, I, D settings / Hysteresis setting by user or default.

Ramp HOLD: Suspends the ramp at the last value.

Ramp ON: Initiates the ramp. Ramp rate and soak time settings as programmed by the user or default.

- **SENSOR OPEN CONDITION:**

The sensor open condition is selectable between Auto and Manual. If the sensor open condition is set to Auto, then all the relays remain off at over range or TC reverse condition. If the selection is Manual then the **sensor fail power level** can be programmed as per requirement.

- **PV BIAS: (DISPLAY OFFSET)**

This function is used to adjust the PV value in cases where it is necessary for PV value to agree with another recorder or indicator, or when the sensor cannot be mounted in correct location.

- **FILTER TIME CONSTANT:**

The filter is an adaptive digital filter that discriminates between measurement noise and actual process changes. If the input signal is increasing too greatly due to measurement noise, increase the filter value. If accurate control is desired, increase the filter time constant whereas if the fastest controller response is required, decrease the filter time constant.

- **ROUNDING INCREMENT:**

This feature can be used to round off the display to a higher value than "1" in cases where the process input and in turn the display is fluctuating. Rounding selections other than 1 cause the process value to round to the nearest rounding increment selected. For example, a rounding increment value of 5 causes 122 to round to 120 and 123 to round to 125. This parameter is not applicable when the resolution is 0.1 (for TC/RTD). Set point values, Set point limits, Alarm values, Input Scaling values, and Analog Scaling values are not affected by rounding. The rounding increment is for controller's display only and does not affect (improve or degrade) the control accuracy of the unit.

- **STANDBY MODE:**

This feature is useful during machine wiring. If standby mode is selected as YES, the following conditions exist:

- a. All displays are OFF.
- b. All outputs are OFF i.e. R1, R2, R3 LEDs are OFF.
- c. M LED is ON.
- d. Analog output is limited to the lower range.
- e. All front keys are disabled.
- f. Access to configuration enabled.

The STND status is preserved on Power OFF.

- **OUTPUT POWER DAMPENING:**

This parameter entered as a time constant in seconds, dampens (filters) the calculated output power. Increasing the value increases the dampening effect. Dampening times longer than, say, one-twentieth to one-fiftieth of the controller's integral time may cause controller instability. This parameter is valid only for analog output models.

### 4.9. LEVEL 5 - COMMUNICATION PARAMETERS

Display	Name & Description	Range	Display condition	Default value
<code>bAud</code>	Baud Rate	2400/ 4800/ 9600 1922/ 3824/ 5726/ 11522	—	9600
<code>Addr</code>	Communication station No.	1 to 99	—	1
<code>Par 1</code>	Parity	none/EVEN odd	—	none
<code>StOP</code>	Stop bit	1/2	—	1

• CONNECTION DIAGRAM

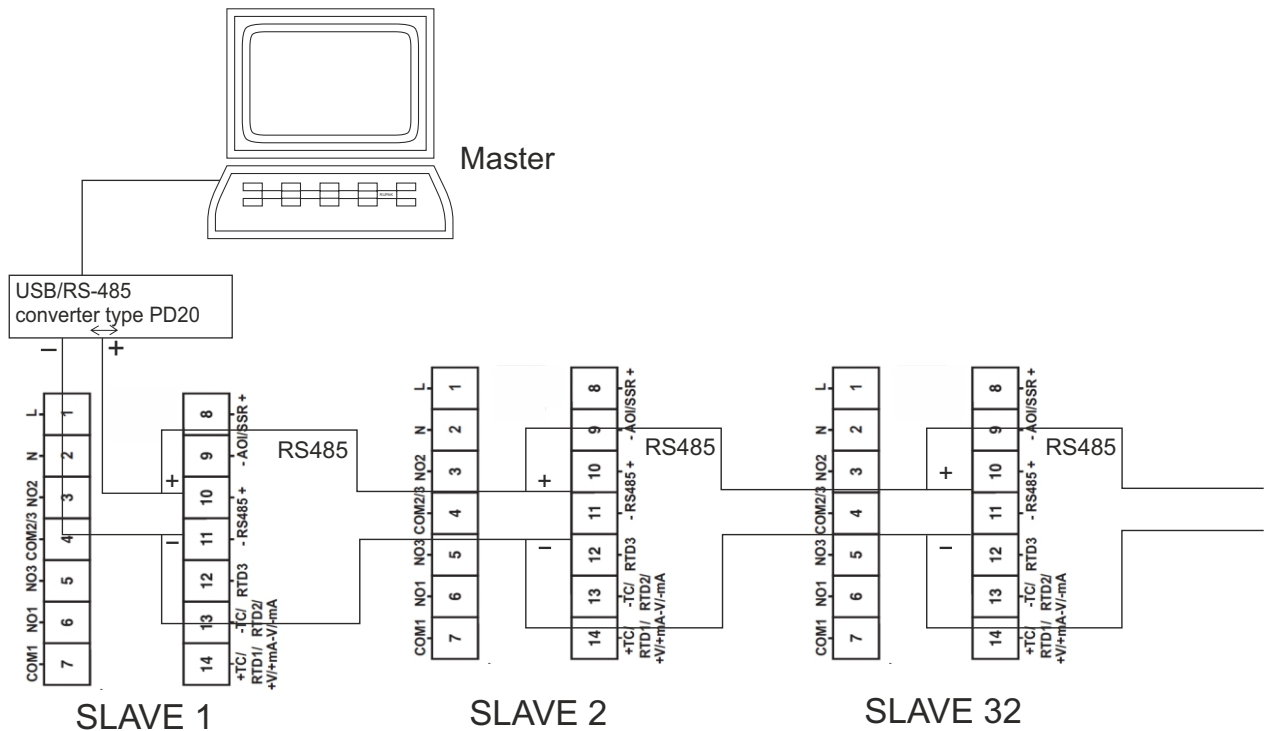

**Note:**

1. Maximum 32 slave controllers can be connected to the master.
2. The total cable length should not exceed 500 meters.
3. Use shielded twisted -pair cables for RS485 connections.
4. Use terminators having a resistance of 100ohm (1/2 watt).

#### 4.10. LEVEL 6 - PROGRAMMABLE PARAMETER LOCKOUT MODULE

Display	Name & Description	Range	Display condition	Default value
Id	<u>User ID</u>	0000 to 9999	—	0
LOCK	<u>Program access settings</u>	ONL/LEVL	—	LEVL

# If LOCK selection is ONL, the following parameters will be prompted.

Display	Name & Description	Range	Display condition	Default value
SET 1	<u>Lock Set</u>	UNLY/PEAD /LOCY	If LOCK section is ONL	UNLY
SET 2	<u>Lock Set</u>	UNLY/PEAD /LOCY		UNLY
SET 3	<u>Lock Set</u>	UNLY/PEAD /LOCY		UNLY
TUNE	<u>Lock tune</u>	UNLY/PEAD /LOCY		UNLY
HAND	<u>Lock Hand</u>	UNLY/PEAD /LOCY		UNLY
Pb-H	<u>Lock proportional</u>	UNLY/PEAD /LOCY		UNLY
INT.t	<u>Lock integral time</u>	UNLY/PEAD /LOCY		UNLY
DER.t	<u>Lock derivative</u>	UNLY/PEAD /LOCY		UNLY
MAN.R	<u>Lock Manual reset</u>	UNLY/PEAD /LOCY		UNLY
Pb-C	<u>Lock proportional band-</u>	UNLY/PEAD /LOCY		UNLY
CHNG	<u>Change Password</u>	Id-n / Id-y		Id-n

# If LOCK selection is LEVEL, The following parameters will be prompted.

Display	Name & Description	Range	Display condition	Default value
L - 0	<u>Lock Level 0</u>	UNLK/READ /LOCK	—	UNLK
L - 1	<u>Lock Level 1</u>	UNLK/READ /LOCK	—	UNLK
L - 2	<u>Lock Level 2</u>	UNLK/READ /LOCK	—	UNLK
L - 3	<u>Lock Level 3</u>	UNLK/READ /LOCK	—	UNLK
L - 4	<u>Lock Level 4</u>	UNLK/READ /LOCK	—	UNLK
L - 5	<u>Lock Level 5</u>	UNLK/READ /LOCK	—	UNLK
L - 9	<u>Lock Level 9</u>	UNLK/READ /LOCK	—	UNLK
CHNG	<u>Change password</u>	Id - N/Id - Y	—	Id - N
NEW	<u>New password</u>	—	NEW = Id-Y	0

**NOTE:**

UNLK - Full access to the particular level / parameter.

READ - Particular level / parameter can be read but not edited.

LOCK - No access to the particular level / parameter.

**4.11. LEVEL 9 - PROFILE CONTROL :**

Display	Description	Range	Display condition	Default value
P.PPŁ	Full profile repeat cycle count	0 to 99	In level 4, When = ON PFFŁ	1
PPFL	Profile number	1 to 10		1
PŁPŁ	Current profile repeat cycle count	0 to 99		1
PdŁ	Power down resume status	ArSt / StOP / rESU		ArPSŁ
LIŁŁ	Link Profile	NO / 1 to 10		ŃŃ
ALŁŁ	Alarm duration	1 to 99 sec		3
dŁU.W	Deviation hold	dS / En		d5
SŁPŁ	Start from step number	1 to 16		1
SŁŁP	Number of steps in current profile	Number (1 to 16)		16
A - 1	Auxillary output	nA/OFF/ON/ALrM		ŃŃ
P - 1	Program target temperature	SPHL to SPLŁ		0
Ł - 1	Program ramp time (Hr.Min)	00.00 to 99.59		0.01

**To make profile:**

- Program the ramp temperature, time etc for each step.
- Note Full profile Repeat and program repeat to be set 1 if profile is not to be repeated. By programming Repeat profile=0, the profile is repeated indefinitely
- Current Profile Repeat is the no. of times the current profile is to be repeated.
- Full profile Repeat is the no. of times the full profile is to be repeated. This is advantageous in cases when a profile is linked with another profile.

**Online display option**









This function allows user to view online display options.

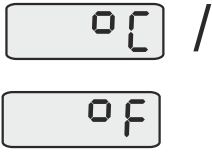

Note: The parameters shown below are not prompted if they are locked in level 6

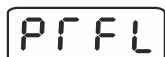
DISPLAY	DESCRIPTION	DISPLAY CONDITION
SŁŁ1	Set point 1	—
SŁŁ2	Set point 2	Online access for Set 2 not valid if Auxillary output = Sensor Break / OFF / Retransmission



DISPLAY	DESCRIPTION	DISPLAY CONDITION
SEt3	Set point 3	Online access for Set 3 not valid if Alarm mode = Sensor Break / OFF.
tUNE	Auto tune	Online access for Auto tune is not valid if PB-Heat=0 and HC =no or PB-Cool=0.
HANd	Hand output percentage	This parameter is not prompted if Pb- H = 0
Pb-1	Proportional band - heat	—
It-1	Integral time	Integral time is not prompted if PB = 0
dT-1	Derivative time	Derivative time is not prompted if PB = 0
MANR	Manual reset	Manual reset is prompted only if Integral-main=0 and PB-heat > 0.
Pb-C	Proportional band - cool	This parameter is prompted only if HC = yes.
r-SP	Ramp set point	This parameter is prompted only if Ramp is ON / Hold. This parameter is read only and cannot be altered.
PERC	Output percentage	This parameter is read only and cannot be altered.
SOAK	Elapsed soak time	Note: This parameter is prompted only if Ramp is ON / Hold. This parameter is read only and cannot be altered.

DISPLAY	DESCRIPTION	DISPLAY CONDITION
	Temperature unit	Note: This parameter is not prompted for 0-10 V / 4-20mA. This parameter is read only and cannot be altered.
	Alarm acknowledge 1	Note: This parameter is prompted only if Alarm1 is ON and Latch is ON.
	Alarm acknowledge 2	Note: This parameter is prompted only if Alarm2 is ON and Latch is ON.
	Blank	—
	Elapsed soak time	Note: This parameter is prompted only if Ramp is ON/HOLD and if P.sel is Pr. This parameter is read only and cannot be altered
	PrFL	RUN/STOP/HOLD only if Profile=ON in Level 4.
	Profile number	Displays the current Profile number only if Profile = ON in Level 4.
	Profile step number	Displays the current step number of the running profile only if Profile = ON in Level 4.
	Profile time remaining	Displays the time remaining for the current step only if Profile = ON in Level 4.
	Profile elapsed time	Displays the elapsed time for the current step only if Profile = ON in Level 4.

DISPLAY	DESCRIPTION	DISPLAY CONDITION
	Auxiliary output status	ON / OFF / Not applicable / Alarm only if Profile = ON.
	Program temperature	SPLL to SPHL only if Profile = ON.
	Program ramp time	00.00 to 99.59 only if Profile = ON.

## PROFILE PARAMETER :

### Auxiliary output settings :

**OFF** = The auxiliary output will be OFF during the step

**ON** = The auxiliary output will be ON during the step

**NA** = The Auxiliary output does not have any interference with the step and that its output will be dependent on the settings done in Level 2

**ALARM** = Alarm can be programmed for specified duration at the end of each step.

1. When entering the time set points, use total elapsed time, not the time differences between steps. i.e enter the relative time from the start of profile

2. While linking a profile with another, note that the time is to be started from 0 for the next linked profile. (and not to the relative time from the previous profile).

3. All 8 profiles can be linked resulting in a total of 160 steps.

160 steps can be repeated up to 99 times.

## PROFILE PARAMETER :

### Options of Power down resume :

**Stop** : The profile is in STOP mode at every power ON. To run profile, select RUN command.

**Restart** : The selected profile is automatically re-started at power ON ( without issuing RUN command) from start.

**Resume** : The selected profile is resumed from the same point at power ON that was during power OFF. Note here that if the Process value has dropped to a certain value then the process is in HOLD mode (i.e. Ramp SP and elapsed time is not changed ) till the PV reaches the ramp sp value (the PV value which was at power OFF ), Thereafter process resumes.

### To Tune the instrument :

1. Select  PrFL = ON in Level 4
2. Set the set point SET1 (from online) at which the instrument is to be tuned. Since there is only one set of PID parameters, set SET1 to a value at which max. Optimization in the process is required
3. Also note that during ramp up/down, PD control is performed. Only during soak time is the full PID operational. Hence it is also advisable to tune at soak temperature.
4. To initiate tuning, set TUNE ON (from online). Tuning is indicated by the tune LED (T) blinking.
5. Tuning will be terminated if SET 1 is less than ambient ( Room Temperature).
6. After the tuning is OVER, P, I, D, DAC, Cycle time are calculated internally. One can alter or view these values in Level 1.
7. Select  PrFL = ON in Level 4.

### To run the profile :

1. Ensure  PrFL = ON in Level 4 with all parameter settings are desired.
2. From online display options , Select Profile No (Pr.No) to desired value.
3. From online display options, Select Profile (PrFL) as RUN.
4. Once the Run command is issued, all the profile related online parameters are enabled. One can view / alter any of these online parameters.
5. To hold a profile, select Profile (PrFL)= Hold. This will hold the Ramp-SP and Elapsed time at the last value.
6. To re-start, select Profile ( PrFL) = RUN.
7. To alter / skip the running step, select running ramp / time parameters from online.
8. One can modify the other steps (if required) in Level 3.
9. Note that the profile related parameters ( Repeat, Power down resume, no. of steps, Link ) will NOT be re-loaded in running profile if altered while the profile is in RUN/HOLD mode, & from online parameter menu.

## 5. USER GUIDE

### • AUTO TUNING:

Auto tuning is a function whereby the controller learns the process characteristics by itself and automatically sets the required P,I and D values. The auto-tuning function can be activated at any time during the process after power ON , while temperature is rising or when control has stabilized. Autotune is indicated by T LED blinking After the auto tuning procedures are completed, the T LED will stop flashing and the unit will revert to PID control by using its new PID values. The PID values obtained are stored in the nonvolatile memory.

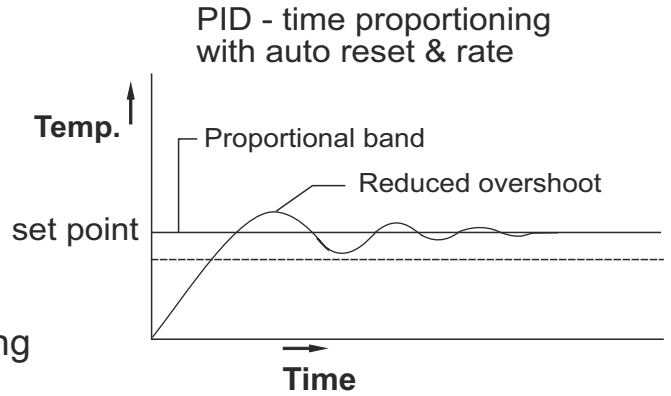

The auto-tuning is applied in cases of :

- Initial setup for a new process
- The set point is changed substantially from the previous auto-tuning value.
- The control result in unsatisfactory.

The following controller parameters are automatically adjusted by Auto- tune according to the characteristics of the process:

Proportional Band (Pb-1)

Integral Time (It-1)

Derivative Time (dt-1)

Input Filter (FtC)

If the control performance by using auto-tuning is still unsatisfactory, the following rules can be applied for further adjustment of PID values:

ADJUSTMENT SEQUENCE	SYMPTOM	SOLUTION
(1) Proportional Band (PB)	Slow Response	Decrease PB
	High overshoot or Oscillations	Increase PB
(2) Integral Time (IT)	Slow Response	Decrease IT
	Instability or Oscillations	Increase IT
(3) Derivative Time (TD)	Slow Response or Oscillations	Decrease TD
	High Overshoot	Increase TD

- **PROPORTIONAL BAND:**

Proportional band is the area around the set point where the controller is actually controlling the process; the output is at some level other than 100% or 0%.

Proportional band is expressed in terms of degree centigrade.

If the proportional band is too narrow an oscillation around the setpoint will result. If the proportional band is too wide the control will respond in a sluggish manner, could take a long time to settle at set point and may not respond adequately to upsets.

- **MANUAL RESET:**

Virtually no process requires precisely 50% output on single output controls or 0% output on two output controls. The adjustment called manual reset allows the user to redefine the output requirement at the setpoint. A proportioning control without manual or automatic reset will settle out somewhere within the proportioning band but likely not on the setpoint.

- **INTEGRAL TIME:**

Integral time is defined as the time, in seconds, which corrects for any offset (between setpoint and process variable) automatically over time by shifting the proportioning band. Integral action (also known as “automatic reset”) changes the output power to bring the process to setpoint. Integral times that are too fast (small times) do not allow the process to respond to the new output value. This causes over-compensation and leads to an unstable process with excessive overshoot. Integral times that are too slow (large times) cause a slow response to steady state errors. Integral action may be disabled by setting the time to zero. If time is set to zero, the previous integral output power value is maintained. If integral action is disabled, manual reset is available by modifying the output power offset (“MNL.r” initially set to zero) to eliminate steady state errors. The controller has the feature to prevent integral action when operating outside the proportional band. This feature is called “**antireset wind-up**”.

- **DERIVATIVE TIME**

Derivative action is used to shorten the process response time and helps to stabilize the process by providing an output based on the rate of change of the process. In effect, derivative action anticipates where the process is headed and changes the output before it actually “arrives”. The derivative time is calculated in seconds. Increasing the derivative time helps to stabilize the response, but too much derivative time coupled with noisy signal processes, may cause the output to fluctuate too greatly, yielding poor control. None or too little derivative action usually results in decreased stability with higher overshoots. No derivative action usually requires a wider proportional and slower integral times to maintain the same degree of stability as with derivative action. Derivative action is disabled by setting the time to zero.

## • DERIVATIVE APPROACH CONTROL:

Derivative approach control (DAC) helps in reducing overshoot at startup. The control output cutoff point is derived as  $DAC \times \text{Proportional band}$ . Note that the DAC value is automatically calculated and fed after auto tuning (if tuning is initiated at startup).

## • AUTO-TUNE OF HEAT/COOL SYSTEMS:

During Autotune of heat/cool systems, the controller switches the cooling output (O2) ON and OFF in addition to the heat output (O1). The heat/cool overlap deadband parameter (db in Level 2) determines the amount of overlap or deadband between the two outputs during Autotune.

For most applications, set this parameter to 0.0 prior to starting Autotune. After the completion of Autotune, this parameter may need to be reset. It is important that external load disturbances be minimized, and if present, other zone controllers idled as these may have an effect on the PID constant determination.

Some water cooled processes exhibit an extreme non-linear gain characteristic. That is, the process cooling gain starts very high and flattens out deeper into the cooling region. This effect may result in regular oscillations at setpoint as the controller applies heat to counteract the effect. These processes may benefit from a lower cooling fan setting and/or reduced water flow in the jacket or manifold. The process heat and cool gains should be balanced as much as possible, and the controller gains adjusted to the process.

**Self Tune (ST) :** It is used where modification of PID parameters is required repeatedly due to frequent change in process condition eg. Setpoint.

*! Tune LED blinks at slower rate when Self-tuning is in progress.*

*! At the completion of self-tuning, Tune LED stop blinking.*

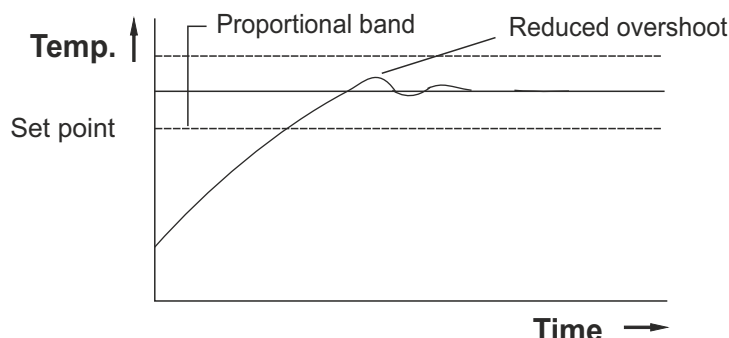

Self-tuning is initiated under the following conditions :

- When setpoint is altered.
- When tune mode is altered. (TUNE=ST)

ST will start only if  $PV < 50\%$  of setpoint.

ST will work only when  $ACT=RE$ .



**Adaptive Tune (ADT) :** It is used where modification of PID parameter is required repeatedly due to frequent change in process condition eg. Set point , Change in environmental conditions etc.

Adaptive Tune LED blink's at faster rate when Adaptive tuning is in progress.  
ADT LED will stop blinking after completion of the tuning process

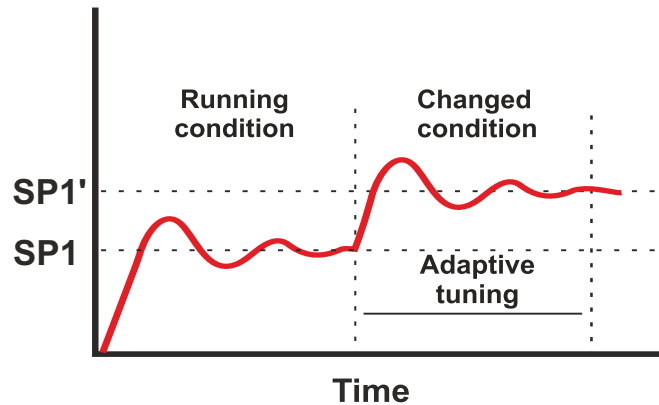

- **ALARM MODES:**

- **Absolute alarms (Independent Alarm) :**

Absolute alarm is a self-existent alarm independent of the main set point. For eg. If the main set point is  $100^{\circ}\text{C}$  and absolute alarm is set as  $110^{\circ}\text{C}$ , the alarm will be activated at  $110^{\circ}\text{C}$ .

There are two absolute alarms-

**Full scale High Alarm:** sets off alarm signal when temperature rises above set point to a pre-set temperature above scale minimum. **Refer Fig: d.**

**Full scale Low Alarm:** sets off alarm signal when temperature falls below setpoint to a pre-set temperature above scale minimum. **Refer Fig: e.**

- **Deviation alarms (Error alarm):**

This alarm is activated at an error on the main set point. For eg. If the main set point is  $100^{\circ}\text{C}$  and deviation alarm is set to  $+5^{\circ}\text{C}$  then the alarm will be activated at  $100+5=105^{\circ}\text{C}$ . In case of deviation band alarm the alarm will be activated on both sides of set point i.e. At 95 and 105.

There are three deviation alarms -

**Deviation High Alarm:** sets off alarm signal when temperature rises above a pre-set temperature above the set point. **Refer Fig: a.**

**Deviation Low Alarm:** sets off alarm signal when temperature falls below a pre-set temperature below the set point. **Refer Fig: b.**

**Deviation Band Alarm:** sets off alarm signal when temperature rises above or falls below a pre-set temperature above or below the set point. **Refer Fig: c.**



• **BREAK ALARM:**

Break Alarm: sets off alarm signal when sensor break / under range occurs.

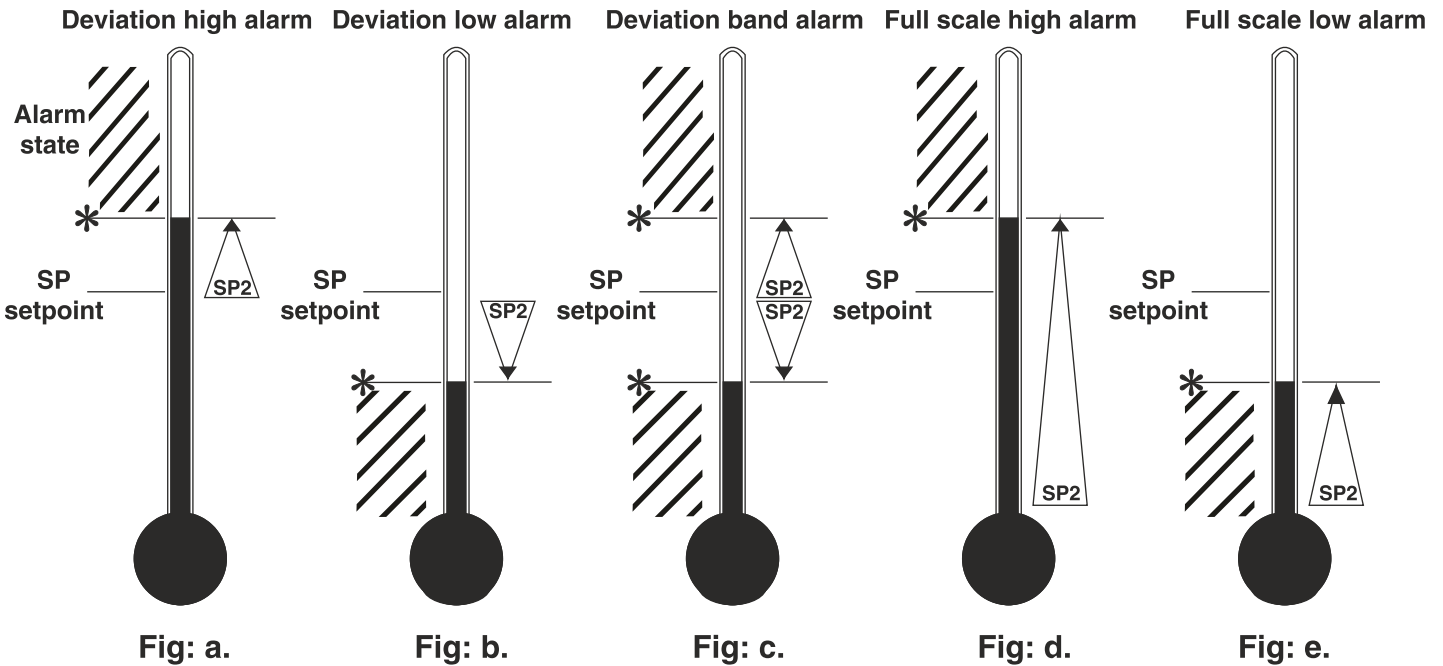

• **Zone PID:**

There are 4 control Zones each having a set point and associated P, I and D values which can be programmed as per the process requirements. A control Zone is selected automatically and implemented as per the set value programmed, to accommodate changing process requirements. The corresponding P, I, D values will be used to control the process. The main advantage of Zone PID is in processes where there is a requirement of frequent tuning, due to change in setpoint. Consider a case where the process needs to be controlled at two different set points: 100°C and 400°C.

The Zone set points may be programmed as:

1. Zone setpoint 1 (Level1) : 150°C (This implies that for 0 < set1 < 150, Zone1 PID values will be considered.)
2. Zone setpoint 2 (Level1) : 450°C (This implies that for 150 < set1 < 450, Zone2 PID values will be considered.)

The P, I, D values for the respective Zones can be manually fed or can be tuned automatically.

**How to tune the Zones**

NOTE : Zone setpoint is not the tuning setpoint.

**To tune, say, Zone 1 program the following:**

1. Set1 (Online) = 100°C (for eg.) (Zone 1 : 0 - 150°C)

Note: • Set1 < Zone setpoint 1.

- The PID settings derived after tuning are stored in Zone 1.
- After tuning, for 0 < Set1 < 150°C, PID settings of Zone 1 are applicable.

2. Program Tune = ON (in Level 1 or Online)

3. After tuning the controller is automatically loaded with the new PID values.

Now to tune the next Zone, Zone 2, program the following:

1. Set 1 (Online) = 400°C (Zone 2 :150 - 450°C)



Note: • Zone Setpoint 1 < Set 1 < Zone setpoint 2.

• The PID settings derived after tuning are stored in Zone 2.

• After tuning, for 150 < Set1 < 450°C, PID settings of Zone 2 are applicable.

Similarly, the four different Zones can be programmed.

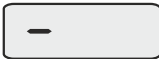
## ERROR INDICATION

Error Indication	Error Description
	Sensor Over Range
	Sensor Under Range
	<b>Error while Tuning</b> 1) Sensor Break while Tuning 2) Change of PV at a Rate < 1°C/10 min while tuning 3) Tuning cycle error



## **LUMEL S.A.**

ul. Słubicka 4, 65-127 Zielona Góra, Poland  
tel.: +48 68 45 75 100, fax +48 68 45 75 508  
[www.lumel.com.pl](http://www.lumel.com.pl)

### **Technical support:**

tel.: (+48 68) 45 75 143, 45 75 141, 45 75 144, 45 75 140  
e-mail: [export@lumel.com.pl](mailto:export@lumel.com.pl)

### **Export depart:**

tel.: (+48 68) 45 75 130, 45 75 131, 45 75 132  
e-mail: [export@lumel.com.pl](mailto:export@lumel.com.pl)

### **Calibration & Attestation:**

e-mail: [laboratorium@lumel.com.pl](mailto:laboratorium@lumel.com.pl)